

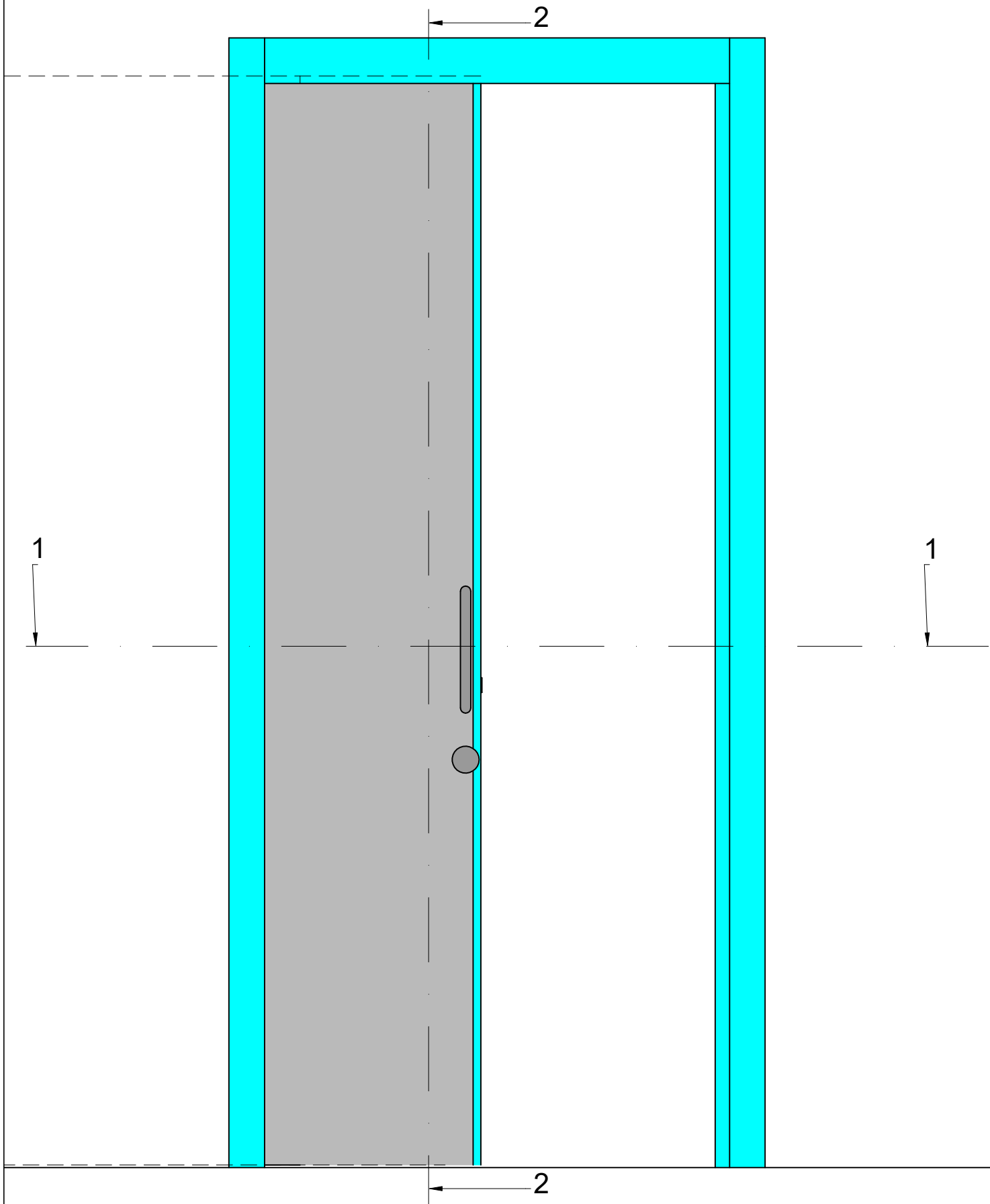

Internal sliding door  
squared frame (ray 2,5 mm)



ALL RIGHTS ARE RESERVED FOR THE DRAWING, REPRODUCTION AND DISCLOSURE WITHOUT PRIOR CONTEST IS PROHIBITED		
PRODUCT	COMMUNITY LINE	Laminate door leaf and aluminium or steel frame
		SCALE 1:10
	DESCRIPTION	INTERNAL SLIDING DOOR
SMART OPENING SYSTEMS		

Internal sliding door  
squared frame (ray 2,5 mm)

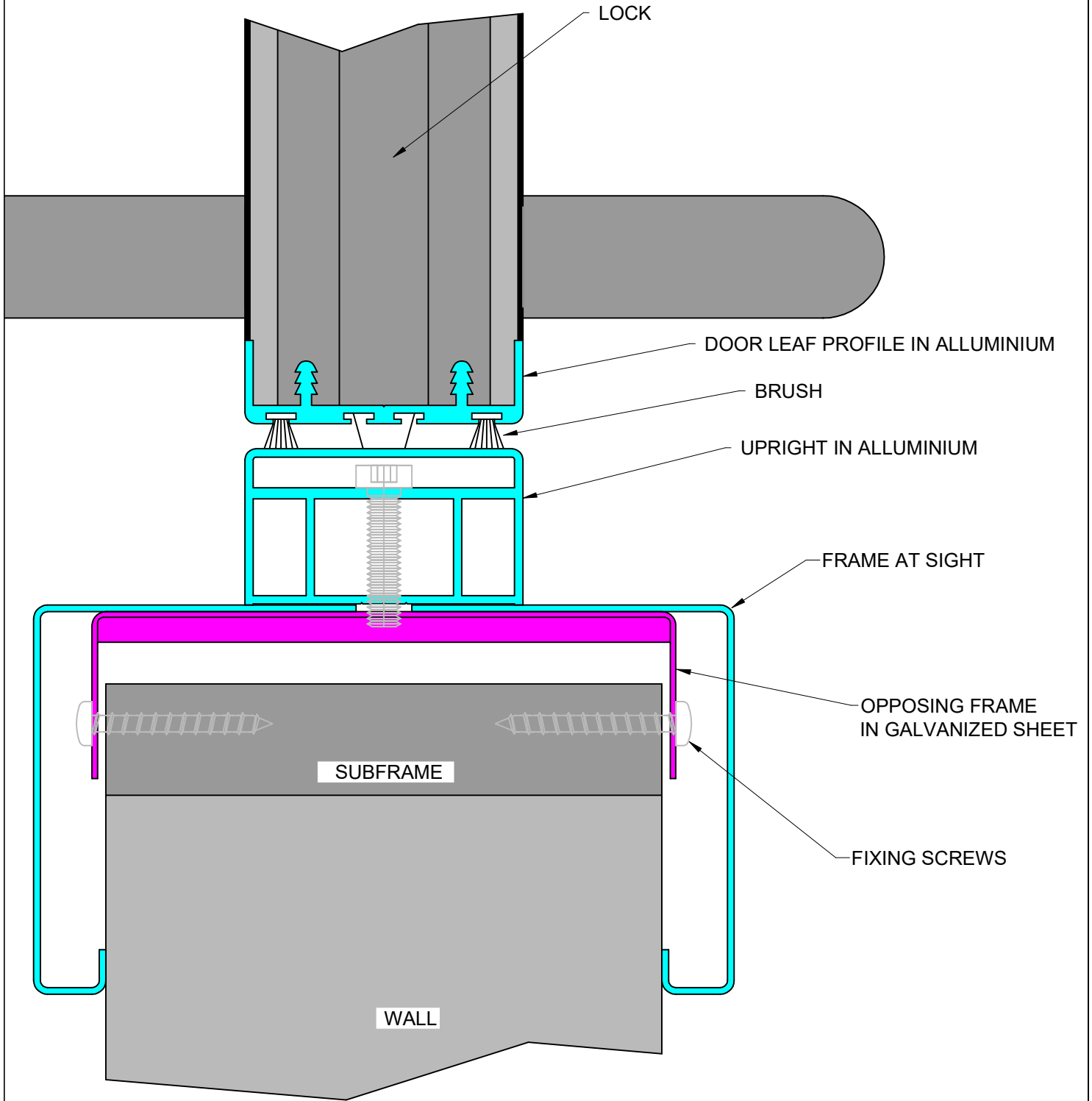

SECT. 1-1

ALL RIGHTS ARE RESERVED FOR THE DRAWING, REPRODUCTION AND DISCLOSURE WITHOUT PRIOR CONTEST IS PROHIBITED		
PRODUCT	COMMUNITY LINE	Laminate door leaf and aluminium or steel frame
		SCALE 1:1
	DESCRIPTION	SECTION 1-1 LOCK SIDE INTERNAL SLIDING DOOR
 SMART OPENING SYSTEMS		

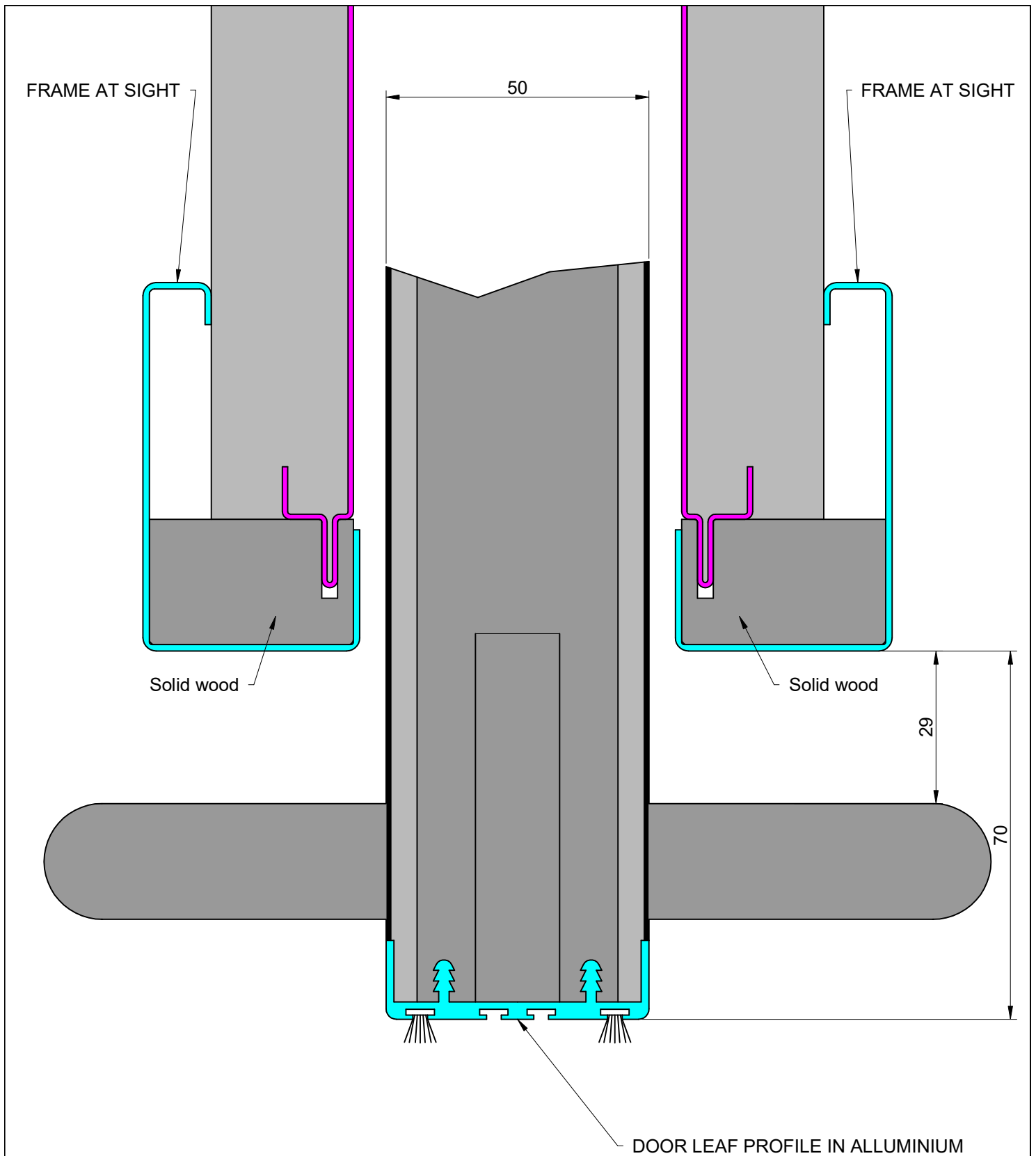

Internal sliding door  
squared frame (ray 2,5 mm)

SECT. 1-1

ALL RIGHTS ARE RESERVED FOR THE DRAWING, REPRODUCTION AND DISCLOSURE WITHOUT PRIOR CONTEST IS PROHIBITED		
PRODUCT	COMMUNITY LINE	Laminate door leaf and aluminium or steel frame
		SCALE 1:1
	DESCRIPTION	SECTION 1-1 HINGE SIDE INTERNAL SLIDING DOOR

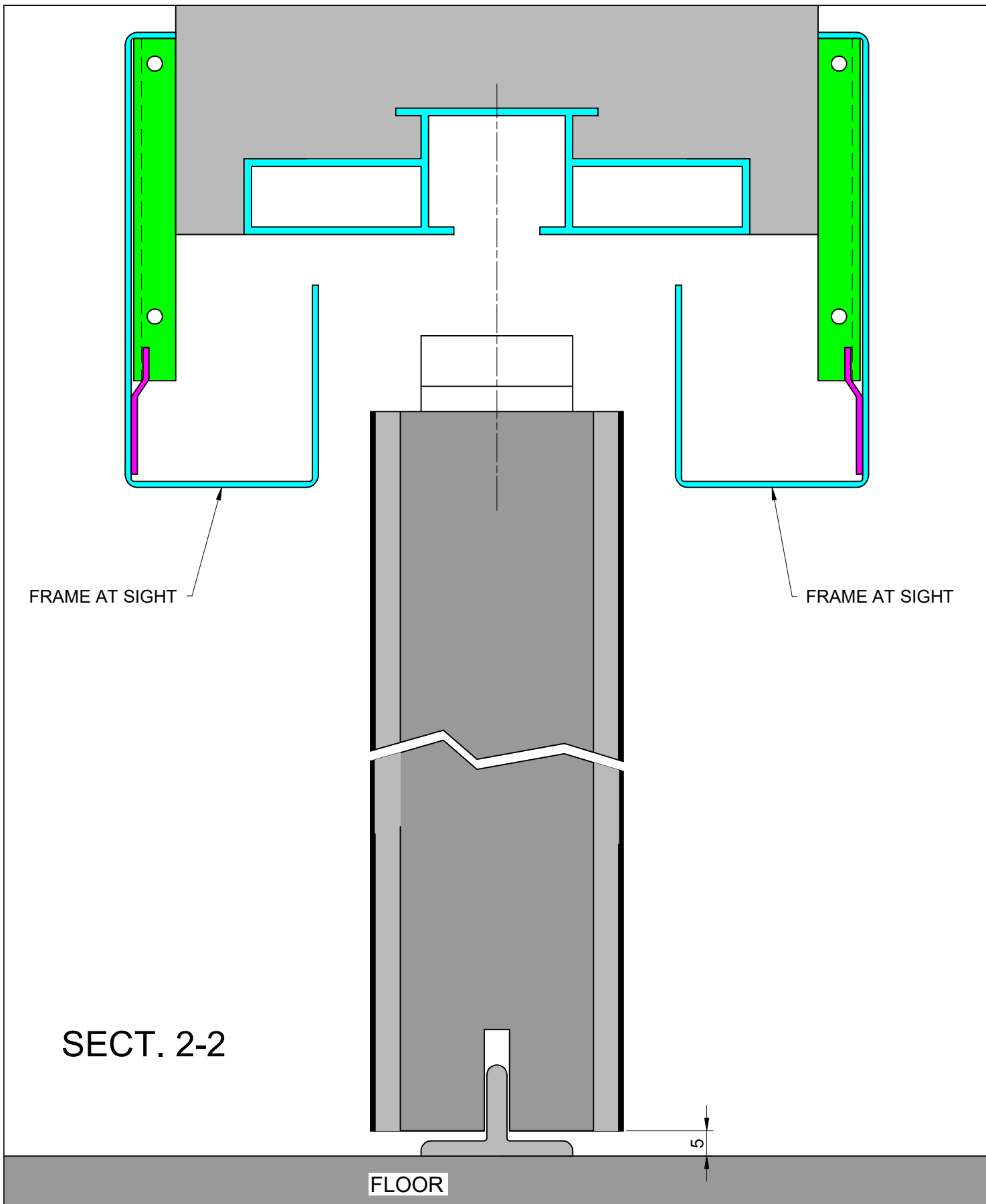

FRAME AT SIGHT

FRAME AT SIGHT

SECT. 2-2

FLOOR

5

Internal sliding door  
squared frame (ray 2,5 mm)

ALL RIGHTS ARE RESERVED FOR THE DRAWING, REPRODUCTION AND DISCLOSURE WITHOUT PRIOR CONTEST IS PROHIBITED		
PRODUCT COMMUNITY LINE	Laminate door leaf and aluminium or steel frame	SCALE 1:1
 SMART OPENING SYSTEMS	DESCRIPTION SECTION 2-2 VERTICAL INTERNAL SLIDING DOOR	